

Tokyo Performing Arts Market 2009

■ Plan View of a booth

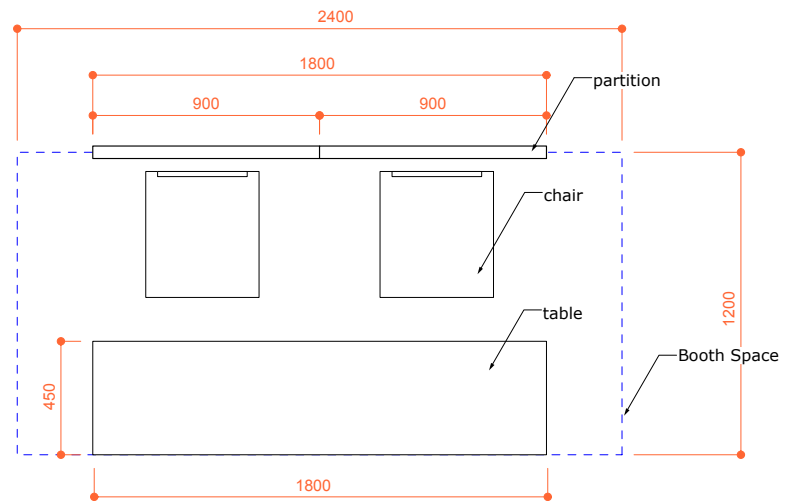

■ Booth Image 1

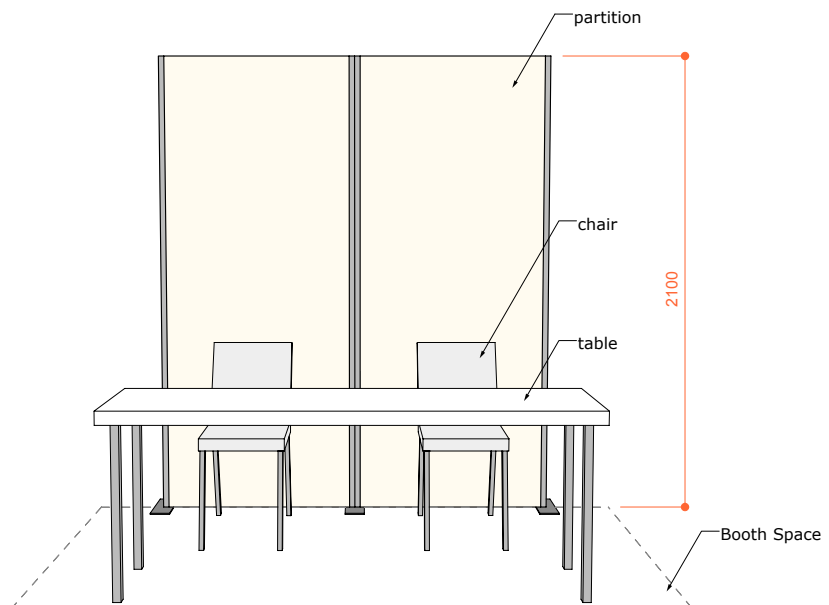

■ Booth Image 2

